

# KOBELCO

SK380XDLC-10

## SK380XD<sup>LC</sup>

■ **Bucket Capacity :**

1.6 - 2.3 m<sup>3</sup> (ISO heaped)

■ **Engine Power :**

209 kW / 2,100 min<sup>-1</sup> (ISO 14396)

■ **Operating Weight :**

37,400 - 37,800 kg



**We Save You Fuel**  
Achieving a Low-Carbon Society

# Power Meets Efficiency

In line with KOBELCO's concept of earth-friendly construction machinery that will work long and hard on any site on the planet, the rugged machine body is newly designed, and comprehensive reinforcement makes the attachment more robust.

It all adds up to KOBELCO's toughest ever mining excavator. The latest hydraulics technology delivers both high-powered output and lower fuel consumption.

As the 10th generation model of KOBELCO's SK series, the SK380XDLC meets the needs of the most punishing mining sites with a performance that simply astounds.





Increase in productivity means "Power"

Higher fuel saving means "Efficiency"

\*in Eco-mode compared to S-mode on the SK330-8

# Even stronger attachment

## Reinforced arm exhibits strength

### Thick steel plate **NEW**



Arm top



Arm foot

Thickness of steel plate has been increased to give more strength.

Base plate thickness has been increased.

### Modified Foot Boss Shape **NEW**



The arm foot boss shape has been modified and improved to distribute stress, delivering more strength for tasks like digging next to a wall.



### Rock Guards

Specially designed long, solid rock guard installed to prevent damage to arm.





Increase in productivity means "Power"

The boom and arm that take the greatest punishment are significantly reinforced.

**Newly developed mining boom made of thicker steel plate**

**Featuring an XD Boom** NEW

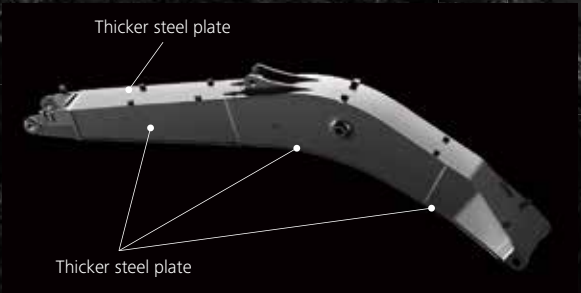

The XD boom features stronger plates compared to the HD booms of standard machines, which increases longevity even under the toughest working conditions.

**Big cross-section boom** NEW



Newly designed, big cross-section boom for unbeatable durability under harsh working conditions.

**Protective Guards that Cover the Main Upper Machinery**

**Upper Under Covers**

Thick covers with increased durability compared to standard models.



# Increase in productivity means "Power"

Powerful travel system for easy travel over loose rocks, and highly reliable filtration system ensure higher machine performance.

**Crawlers Built for Unbeatable Durability compared to standard models\***

\*SK350 series

## Reinforced Guide Frame



Reinforced guide frame prevents deformation caused by impact or encroaching of loose stones.

## Track Guides



Large, reinforced track guides are installed in three locations.

## Double-support outer flange upper rollers



## Lower Flame Underside Cover



Hydraulic piping and equipment protected against damage from rubble and stony ground.

## Track Links



The size and durability of the track link are increased compared to standard models.

## Thicker steel plate for shoes



Reinforced HD shoes of thick steel plate to master rough, stony ground.

## Reinforced Travel Motor Cover



Rear of travel motor cover is reinforced.



## Improved Filtration System Reliability

Clean, contaminant-free fuel and hydraulic fluid are essential to stable performance.

The improved filtration systems reduce the risk of mechanical trouble and enhance longevity and durability.

### Fuel Filter NEW

The pre-filter with built-in water separator has 1.8 times more filter area compared to the previous models and with a new final stage maintenance free fuel filter to maximize filtering performance.

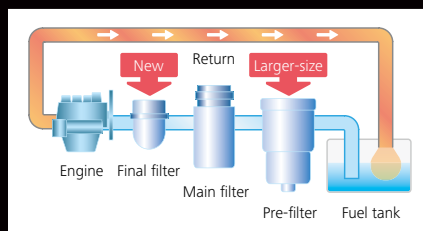

### Hydraulic Fluid Filter NEW

Recognized as the best in the industry, our Premium-fine filter separates out even the smallest particles. New cover prevents contamination when changing filters.

### Metal Mesh Cover Air Cleaner NEW

Metal mesh cover ensures strength and durability.

### Hydraulic Fluid Filter Clog Detector NEW

Hydraulic tank pressure sensor monitors the pressure difference between the return line and tank inside pressure to determine the degree of clogging. If the difference exceeds a predetermined level, a warning appears on the multi-display, so any contamination can be trapped by the filter and replaced before it reaches the hydraulic fluid in the tank.

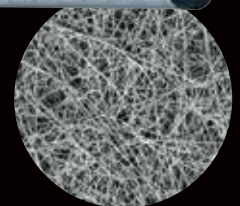
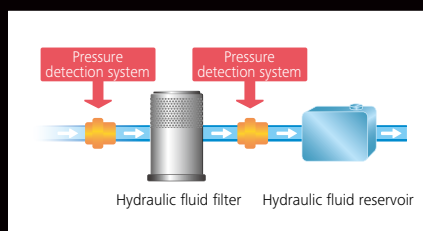

Enlarged filter image

# Evolution Continues, with Improved Fuel Efficiency.

Higher fuel saving means "Efficiency"

The new arm interflow system more efficiently controls hydraulic fluid flow, and significant reduction of in-line resistance and pressure loss boosts fuel efficiency.

## Hydraulic System: Revolutionary Technology Saves Fuel

## Energy saving system saves fuel further

### Arm Regeneration System NEW

When lowering the boom, this system uses the downward force generated by the boom's weight to push fluid to the excavator arm. This greatly reduces the need to apply power from outside the system.

### Fuel efficient work mode ECO mode NEW

The fuel-saving ECO mode is newly provided to the work mode, selectable according to a desired operation. Fuel consumption can be greatly reduced.

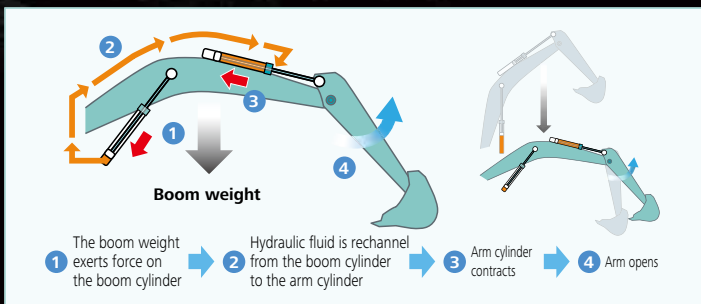

- E** **ECO-mode**  
Used to reduce fuel consumption for small workloads
- H** **H mode**  
Used to prioritize the amount of work done
- S** **S mode**  
Used to strike a balance between workloads and fuel efficiency





### Short 2.6 m arm (reinforced for rocks)

- |                                |                               |
|--------------------------------|-------------------------------|
| ■ Max. Bucket Digging Force    | ■ Max digging reach:          |
| Normal: <b>229kN</b>           | <b>10,610mm</b>               |
| With power boost: <b>252kN</b> | ■ Max digging depth:          |
|                                | <b>6,840mm</b>                |
| ■ Max. Arm Digging Force       | ■ Max vertical digging depth: |
| Normal: <b>207kN</b>           | <b>5,700mm</b>                |
| With power boost: <b>228kN</b> |                               |

### Top Class Traveling Force

Powerful traveling force and drawbar pulling force deliver plenty of speed when climbing slopes or negotiating bad roads, and the agility to change direction swiftly and smoothly.

- Drawbar Pulling Force: **332kN**



# Comfortable Cab Is Now Safer than Ever.

A work environment that is quieter and more comfortable. A cab that puts the operator first is key to improved safety.



## Large cab **NEW**

4% larger than the previous cab capacity. Relaxing environment allows work to be performed in comfort.

## Air Conditioner **NEW** Louvers behind the Seat

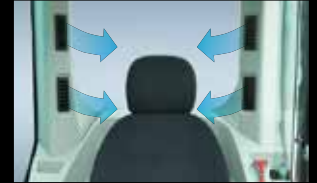

The large air-conditioner has louvers on the back pillars that blow from behind and to the right and left of the operator's seat. They can be adjusted to put a direct flow of cool/warm air on the operator, which means a more comfortable operating environment.

## Super-Airtight Cab **NEW**



The high level of air-tightness keeps dust out of the cab.

## Low Vibration **NEW**

Coil springs absorb small vibrations, and high suspension mounts filled with silicone oil reduce heavy vibration. The long stroke achieved by this system provides excellent protection from vibration.

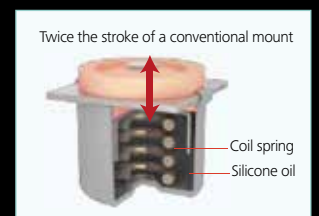

## Multi-Display in Color **NEW**

Brilliant colors and graphic displays are easy to recognize on the LCD multi-display in the console. The display shows fuel consumption, maintenance intervals, and more.



- 1 Analog gauge provides an intuitive reading of fuel level and engine water temperature
- 2 Green indicator light shows low fuel consumption during operation
- 3 Fuel consumption/Switch indicator for rear camera images
- 4 Digging mode switch
- 5 Monitor display switch

## One-Touch Attachment Mode Switch

A simple touch of a button, switches the hydraulic circuit and flow amount to match attachment changes. Icons help the operator to confirm the proper configuration at a glance.

## Comfort

### Broad View Liberates the Operator NEW



The front window features one large piece of glass without a center pillar on the right side for a wide, unobstructed view.

### Large Cab Is Easy to Get in and Out of NEW



The expanded cab provides plenty of room for a large door, more headroom and smoother entry and exit.

### More Comfortable Seat Means Higher Productivity



Vibration absorbing suspension seat



Seat recliner can be pushed back flat



Double slides allow adjustment for optimum comfort

### A Light Touch on the Lever Means Smoother, Less Tiring Work NEW



It takes 38% less effort to work the operation lever, which reduces fatigue over long working hours or continued operations.

### Interior Equipment Adds to Comfort and Convenience

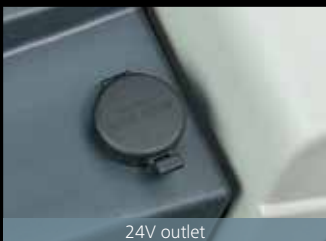

24V outlet

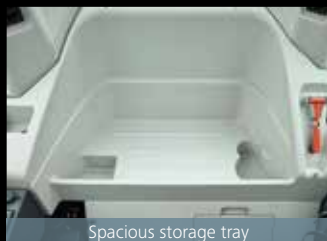

Spacious storage tray



Large cup holder

## Safety

### Wide view during operations High Visibility for Safety



Greater safety assured by rearview mirrors on left and right.



Hammer for emergency exit

# Efficient Maintenance Keeps the Machine in Peak Operating Condition.



MAINTENANCE			
	INTERVAL	REMAINING TIME	EXCHANGE DAY
ENGINE OIL	250	246	--/--
FUEL FILTER	500	496	--/--
HYD. FILTER	1000	996	--/--
HYD. OIL	2000	1996	--/--

Examples of displaying maintenance information

## Machine Information Display Function

- Displays only the maintenance information that's needed, when it's needed
- Self-diagnostic function provides early-warning detection and display of electrical system malfunctions
- Service-diagnostic function makes it easier to check the status of the machine
- Record function of previous breakdowns including irregular and transient malfunction

## Easy, On-the-Spot Maintenance

There is ample space in the engine compartment for a mechanic to do maintenance work inside. The distance between steps is lower so entry and exit is easier. And the mechanic can work in comfort, without contortions or unnatural body positions. Finally, the hood is lighter and easier to raise and lower.



Generous space for maintenance work



Step/Hand rail

## Maintenance Work, Daily Checks, Etc., Can Be Done from Ground Level

The layout allows for easy access from the ground for many daily checks and regular maintenance tasks.



Double-element air cleaner

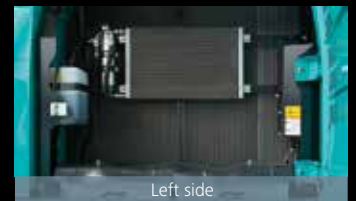

Left side

Simple layout for easy access to radiator and cooling system elements.



Fuel filter with built-in water-separator/Fuel filter

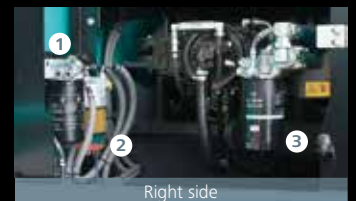

Right side

- 1 Fuel filter
- 2 Fuel filter with built-in water separator
- 3 Engine oil filter

## Easy Cleaning

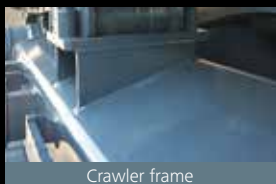

Crawler frame

Special crawler frame design for easy mud removal cleaning.



Detachable two-piece floor mat

Detachable two-piece floor mat with handles for easy removal. A floor drain is located under floor mat.

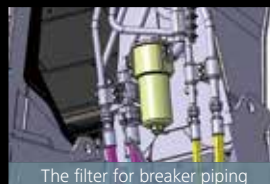

The filter for breaker piping

The Kobelco original filter for breaker piping is installed with breaker hydraulic line.

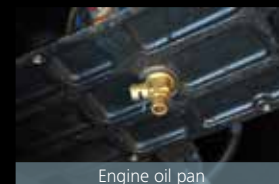

Engine oil pan

Engine oil pan equipped with drain valve.

## More Efficient Maintenance Inside the Cab

Internal and external air conditioner filters can be easily removed without tools for cleaning.



Air conditioner filters

## GEOSCAN

GEOSCAN allows you to use the Internet to manage information from your office for machines operating in all areas. This provides a wide range of support for your business operations.





## Engine

Model	HINO J08E
Type	Direct injection, water-cooled, 4-cycle, 6-cylinder diesel engine with intercooler turbo-charger (Tier3-compliant engine)
No. of cylinders	6
Bore and stroke	112 mm X 130 mm
Displacement	7.684 L
Rated power output	197 kW/2,100 min <sup>-1</sup> (ISO 9249)
	209 kW/2,100 min <sup>-1</sup> (ISO 14396)
Max. torque	969 N•m/1,600 min <sup>-1</sup> (ISO 9249)
	998 N•m/1,600 min <sup>-1</sup> (ISO 14396)



## Hydraulic System

Pump	
Type	Two Variable displacement piston pumps + one gear pump
Max. discharge flow	2 x 294 L/min, 1 x 21 L/min
Relief valve setting	
Boom, arm and bucket	34.3 MPa {350 kgf/cm <sup>2</sup> }
Power Boost	37.8 MPa {385 kgf/cm <sup>2</sup> }
Travel circuit	34.3 MPa {350 kgf/cm <sup>2</sup> }
Swing circuit	29.0 MPa {296 kgf/cm <sup>2</sup> }
Control circuit	5.0 MPa {50 kgf/cm <sup>2</sup> }
Pilot control pump	Gear type
Oil cooler	Air cooled type



## Swing System

Swing motor	Axial-piston motor
Brake	Hydraulic; locking automatically when the swing control lever is in neutral position
Parking brake	Wet multiple plate
Swing speed	10 min <sup>-1</sup> {rpm}



## Attachments

Backhoe bucket and arm combination

Bucket capacity	ISO heaped	m <sup>3</sup>	1.6	1.8	2.0	2.3
	With side cutters		mm	1,470	1,670	1,970
Opening width	Without side cutters	mm	1,390	1,640	1,760	1,770
No. of bucket teeth			5	5	5	5
Bucket weight		kg	1,810	1,830	1,740	1,860
Super short arm 2.25m			◎	○	□	□
Short arm 2.60m			◎	□	□	×
Standard arm 3.30m			□	□	×	×

◎ Standard ○ Recommended □ Earth work digging × Not recommended



## Travel System

Travel motors	Variable displacement piston pump
Travel brakes	Hydraulic
Parking brakes	Wet multiple plate
Travel shoes	48 each side
Travel speed	5.6/3.3 km/h
Drawbar pulling force	332 kN (ISO 7464)
Gradeability	70 % {35°}



## Cab & Control

### Cab

International Comfort Cab with dust free enclosure and with internal pressure of 97pa (earlier cab 27pa). All-weather, sound-suppressed steel cab mounted on the high suspension mounts filled with silicone oil and equipped with a heavy, insulated floor mat.

### Control

Two hand levers and two foot pedals for travel

Two hand levers for excavating and swing

Electric rotary-type engine throttle



## Boom, Arm & Bucket

Boom cylinders	140 mm x 1,550 mm
Arm cylinder	170 mm x 1,788 mm
Bucket cylinder	150 mm x 1,193 mm



## Refilling Capacities & Lubrications

Fuel tank	503 L
Cooling system	35 L
Engine oil	28.5 L
Travel reduction gear	2 x 8.0 L
Swing reduction gear	7 L
Hydraulic oil tank	245 L tank oil level
	410 L hydraulic system



## Working Ranges

Unit: m

Boom	Arm	6.50m		
		Super short 2.25 m	Short 2.6 m	Standard 3.3 m
Range				
a- Max. digging reach		10.36	10.61	11.26
b- Max. digging reach at ground level		10.15	10.4	11.06
c- Max. digging depth		6.51	6.84	7.56
d- Max. digging height		10.29	10.23	10.54
e- Max. dumping clearance		7.06	7.07	7.37
f- Min. dumping clearance		3.73	3.34	2.62
g- Max. vertical wall digging depth		4.33	5.70	6.48
h- Min. swing radius		4.49	4.46	4.31
i- Horizontal digging stroke at ground level		3.39	4.21	5.82
j- Digging depth for 2.4 m (8') flat bottom		6.31	6.65	7.40
Bucket capacity ISO heaped m <sup>3</sup>		2.3	1.6	1.6

## Digging Force (ISO 6015)

Unit: kN

Arm length	Super short 2.25 m	Short 2.6 m	Standard 3.3 m
Bucket digging force	220 242*	229 252*	229 252*
Arm crowding force	232 255*	207 228*	165 182*

\*Power Boost engaged.

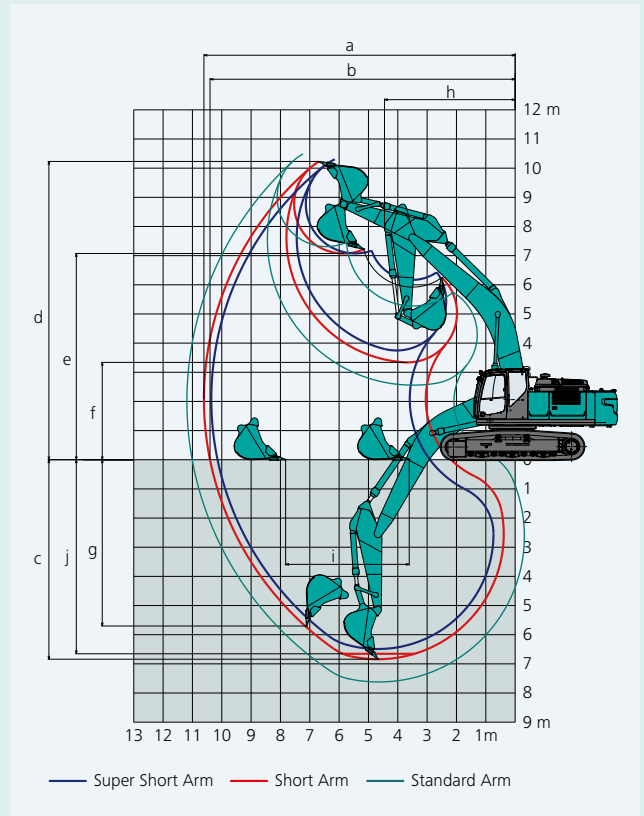

## Dimensions

Arm length	Super short 2.25 m	Short 2.6 m	Standard 3.3 m
A Overall length	11,510	11,380	11,300
B Overall height (to top of boom)	3,770	3,690	3,430
C Overall width		3,190	
D Overall height (to top of cab)		3,170	
E Ground clearance of rear end*		1,220	
F Ground clearance*		500	

Unit: mm

G Tail swing radius	3,600
G' Distance from center of swing to rear end	3,600
H Tumbler distance	4,050
I Overall length of crawler	4,970
J Track gauge	2,590
K Shoe width	600
L Overall width of upperstructure	2,980

\*Without including height of shoe

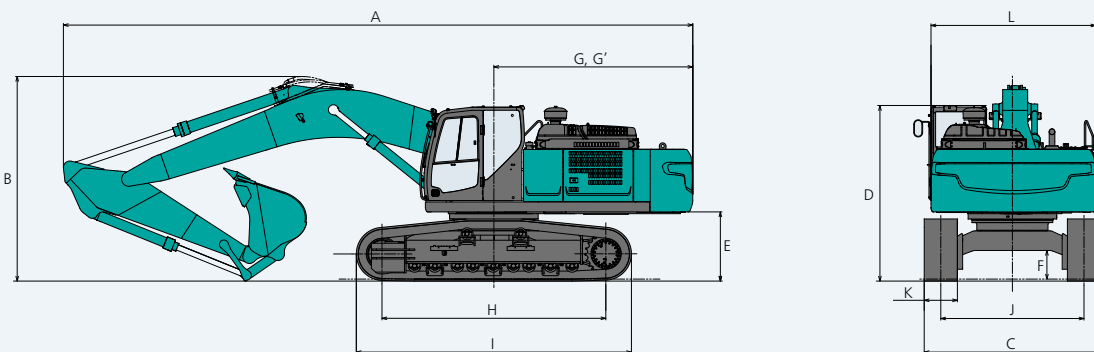

## Operating Weight & Ground Pressure

In standard trim, with standard boom, 2.6 m arm, and 1.6 m<sup>3</sup> ISO heaped bucket

Shaped	Triple grouser shoes (even height)		
Shoe width	mm	600	800
Overall width	mm	3,190	3,390
Ground pressure	kPa	70	53
Operating weight	kg	37,400	37,800

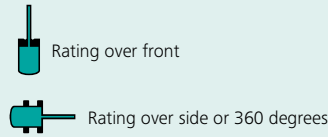
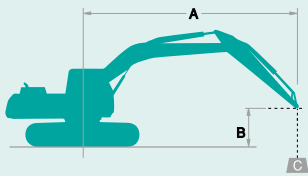

A: Reach from swing centerline to arm top  
 B: Arm top height above/below ground  
 C: Lifting capacities in Kilograms  
 Bucket: Without bucket  
 Relief valve setting: 37.8 MPa (385 kgf/cm<sup>2</sup>)

SK380XDLC		Standard Arm: 3.3 m, Bucket: Without, Shoe: 600 mm, Counterweight: 7,890 kg (Power Boost)															
B	A	1.5 m		3.0 m		4.5 m		6.0 m		7.5 m		9.0 m		At Max. Reach		Radius	
		Rating over front	Rating over side or 360 degrees	Rating over front	Rating over side or 360 degrees	Rating over front	Rating over side or 360 degrees	Rating over front	Rating over side or 360 degrees	Rating over front	Rating over side or 360 degrees	Rating over front	Rating over side or 360 degrees	Rating over front	Rating over side or 360 degrees		
9.0m	kg														*6,370	*6,370	6.56 m
7.5 m	kg									*7,820	7,820				*5,840	*5,840	7.86 m
6.0 m	kg									*7,940	7,720				*5,640	*5,640	8.71 m
4.5 m	kg							*9,730	*9,730	*8,510	7,450	*7,870	5,560		*5,650	5,290	9.25 m
3.0 m	kg					*15,130	14,860	*11,180	9,830	*9,260	7,120	*8,180	5,410		*5,830	4,940	9.52 m
1.5 m	kg					*17,350	13,790	*12,460	9,260	*9,970	6,800	8,210	5,250		*6,200	4,810	9.54 m
G.L.	kg					*18,110	13,320	*13,210	8,890	*10,430	6,570	8,090	5,130		*6,830	4,890	9.33 m
-1.5 m	kg			*15,390	*15,390	*17,760	13,220	*13,270	8,740	10,380	6,470				*7,890	5,220	8.85 m
-3.0 m	kg	*17,520	*17,520	*22,360	*22,360	*16,440	13,350	*12,540	8,780	*9,720	6,520				*8,670	5,950	8.07 m
-4.5 m	kg			*18,270	*18,270	*13,850	13,710	*10,530	9,030						*8,580	7,560	6.88 m

SK380XDLC		Short Arm: 2.6 m, Bucket: Without, Shoe: 600 mm, Counterweight: 7,890 kg (Power Boost)											
B	A	3.0 m		4.5 m		6.0 m		7.5 m		At Max. Reach		Radius	
		Rating over front	Rating over side or 360 degrees	Rating over front	Rating over side or 360 degrees	Rating over front	Rating over side or 360 degrees	Rating over front	Rating over side or 360 degrees	Rating over front	Rating over side or 360 degrees		
7.5 m	kg										*8,810	8,380	7.06 m
6.0 m	kg					*9,410	*9,410	*8,660	7,520	*8,590	6,720	8.00 m	
4.5 m	kg			*13,520	*13,520	*10,520	10,180	*9,080	7,280	*8,570	5,870	8.58 m	
3.0 m	kg					*11,840	9,550	*9,710	6,970	8,470	5,430	8.87 m	
1.5 m	kg					*12,880	9,050	*10,270	6,700	8,300	5,290	8.89 m	
G.L.	kg			*17,940	13,180	*13,320	8,780	10,440	6,520	8,530	5,410	8.66 m	
-1.5 m	kg			*17,040	13,230	*13,030	8,720	*10,240	6,490	*9,150	5,860	8.15 m	
-3.0 m	kg	*19,320	*19,320	*15,220	13,460	*11,810	8,850			*9,180	6,890	7.29 m	
-4.5 m	kg	*14,700	*14,700	*11,840	*11,840					*8,670	*8,670	5.95 m	

SK380XDLC		Super Short Arm: 2.25 m, Bucket: Without, Shoe: 600 mm, Counterweight: 7,890 kg (Power Boost)										
B	A	3.0 m		4.5 m		6.0 m		7.5 m		At Max. Reach		Radius
		Rating over front	Rating over side or 360 degrees	Rating over front	Rating over side or 360 degrees	Rating over front	Rating over side or 360 degrees	Rating over front	Rating over side or 360 degrees	Rating over front	Rating over side or 360 degrees	
7.5 m	kg					*9,510	*9,510			*9,480	9,010	6.73 m
6.0 m	kg					*9,920	*9,920	*9,160	7,500	*9,160	7,130	7.71 m
4.5 m	kg					*11,000	10,130	*9,470	7,290	*9,080	6,200	8.31 m
3.0 m	kg					*12,250	9,520	*10,030	7,000	8,910	5,740	8.61 m
1.5 m	kg					*13,170	9,070	*10,510	6,760	8,730	5,590	8.64 m
G.L.	kg					*13,450	8,850	10,530	6,610	9,020	5,740	8.40 m
-1.5 m	kg			*16,690	13,420	*12,970	8,840	*10,150	6,630	*9,440	6,270	7.87 m
-3.0 m	kg	*17,720	*17,720	*14,640	13,680	*11,460	9,030			*9,290	7,480	6.98 m
-4.5 m	kg			*10,720	*10,720					*8,300	*8,300	5.56 m

- Notes:**
- Do not attempt to lift or hold any load that is greater than these lifting capacities at their specified lift point radius and heights. Weight of all accessories must be deducted from the above lifting capacities.
  - Lifting capacities are based on machine standing on level, firm, and uniform ground. User must make allowance for job conditions such as soft or uneven ground, out of level conditions, side loads, sudden stopping of loads, hazardous conditions, experience of personnel, etc.
  - Arm top pin is defined as lift point.
  - The above lifting capacities are in compliance with ISO 10567. They do not exceed 87% of hydraulic lifting capacity or 75% of tipping load. Lifting capacities marked with an asterisk (\*) are limited by hydraulic capacity rather than tipping load.
  - Operator should be fully acquainted with the Operator's and Maintenance Instructions before operating this machine. Rules for safe operation of equipment should be adhered to at all times.
  - Lifting capacities apply to only machine as originally manufactured and normally equipped by KOBELCO CONSTRUCTION MACHINERY CO., LTD.
  - The above figures indicate machine capacity, but in practice the machine should not be used for lifting loads.

## STANDARD EQUIPMENT

### ENGINE

- Engine, HINO J08E, diesel engine with turbocharger and intercooler
- Automatic engine deceleration
- Auto Idle Stop (AIS)
- Batteries (2 x 12V - 104Ah)
- Starting motor (24V - 5 kW), 60 amp alternator
- Automatic engine shut-down for low engine oil pressure
- Engine oil pan drain cock
- Double element air cleaner
- Pre-air cleaner

### CONTROL

- Working mode selector (H-mode, S-mode and ECO-mode)
- Power Boost

### SWING SYSTEM & TRAVEL SYSTEM

- Swing rebound prevention system
- Straight propel system
- Two-speed travel with automatic shift down
- Sealed & lubricated track links
- Grease-type track adjusters
- 600mm HD triple grouser shoe
- Automatic swing brake
- Tow eyes

### HYDRAULIC

- Boom & Arm regeneration system
- Auto warm up system
- Aluminum hydraulic oil cooler
- Hydraulic fluid filter clog detector
- Pilot line filter

### MIRRORS & LIGHTS

- Two rear view mirrors
- Six front working lights (Two for boom, one for boom cylinder, one for right storage box and two for cab)

### CAB & CONTROL

- Two control levers, pilot-operated
- Horn, electric
- Cab light (interior)
- Luggage tray
- Large cup holder
- Detachable two-piece floor mat
- Headrest
- Handrails
- Intermittent windshield wiper with double-spray washer
- Tinted safety glass
- Pull-up type front window and removable lower front window
- Easy-to-read multi-display color monitor
- Automatic air conditioner
- Emergency escape hammer
- Two cab lights
- Double slide seat
- 7-way adjustable suspension seat

## OPTIONAL EQUIPMENT

- Refilling pump
- Travel alarm
- Cab guards
- Radio, AM/FM stereo with speakers
- Breaker piping with Breaker Filter

Note: Standard and optional equipment may vary. Consult your KOBELCO Dealer for specifics.

Note: This catalog may contain attachments and optional equipment that are not available in your area. And it may contain photographs of machines with specifications that differ from those of machines sold in your areas. Please consult your nearest KOBELCO distributor for those items you require. Due to our policy of continuous product improvements all designs and specifications are subject to change without permission. Copyright by **KOBELCO CONSTRUCTION MACHINERY CO., LTD.** No part of this catalog may be reproduced in any manner without notice.

## KOBELCO CONSTRUCTION MACHINERY CO., LTD.

5-15, Kitashinagawa 5-chome, Shinagawa-ku, Tokyo 141-8626 JAPAN  
Tel: +81 (0) 3-5789-2146  
<https://www.kobelcocm-global.com/>

Inquiries To: